

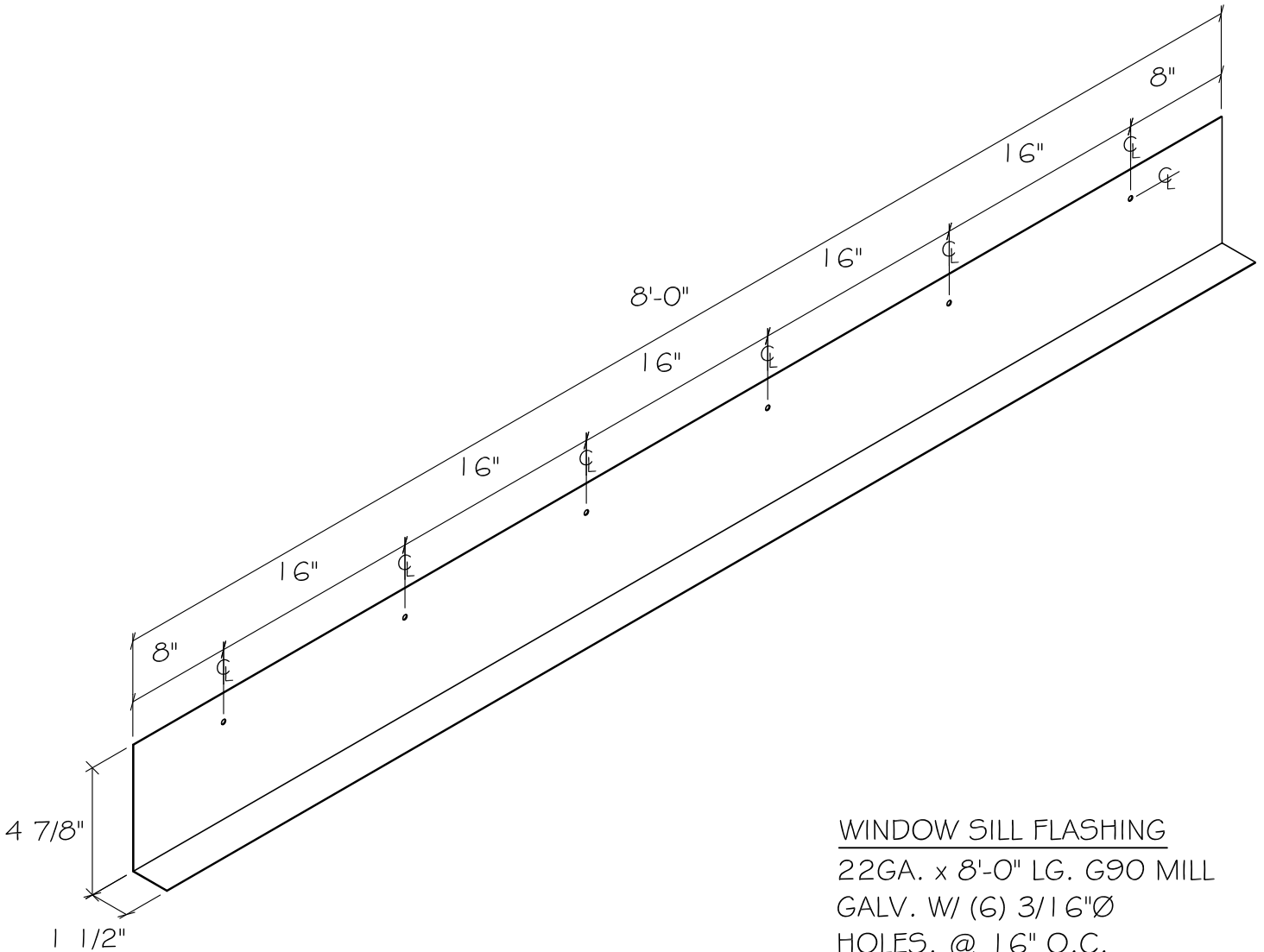

THIN TECH[®]



WINDOW SILL FLASHING
22GA. x 8'-0" LG. G90 MILL
GALV. W/ (6) 3/16"Ø
HOLES. @ 16" O.C.

PIECE QUANTITY:	PROJECT:	NO:
	LOCATION: NEW YORK, NEW YORK	WF-2
	C/O: GLEN - GERY	ISSUE DATE: 01/03/12
	DESCRIPTION: "STANDARD COMPONENT PART SHEET"	SCALE: N.T.S.