

This drawing has been reviewed for dimensions, faces, and specifications and I agree to them.

Qty : _____

CATALOG SHAPE

Signature _____ Title _____ Date _____

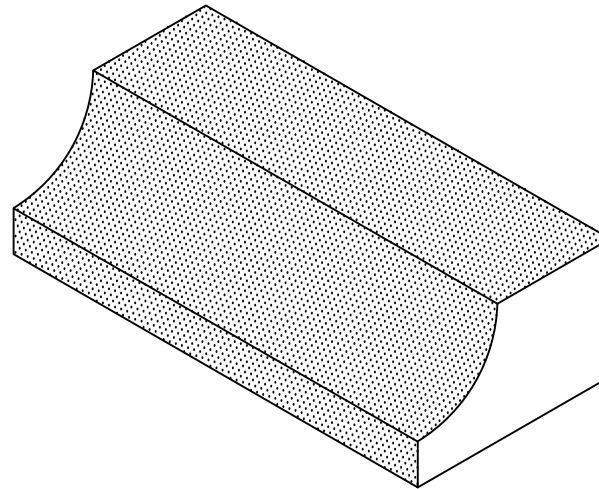
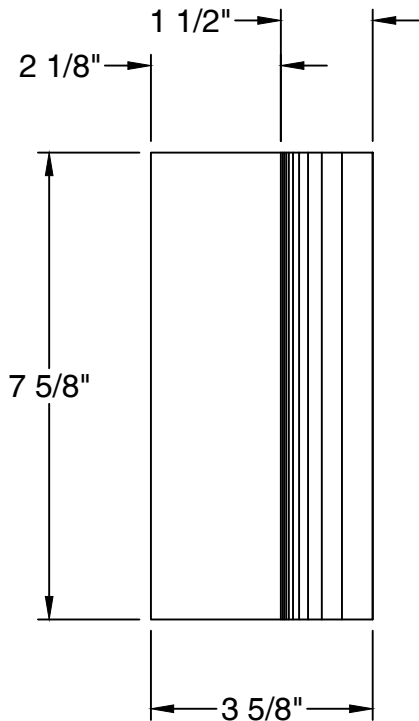
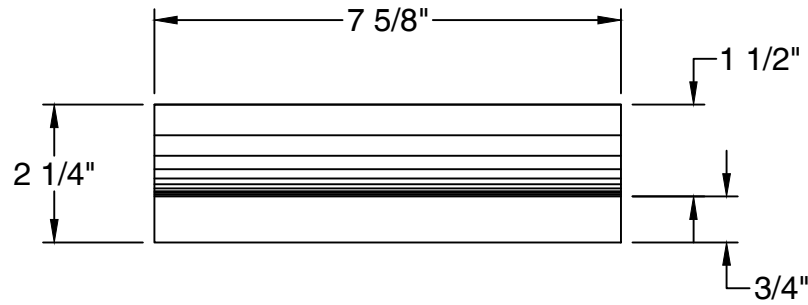
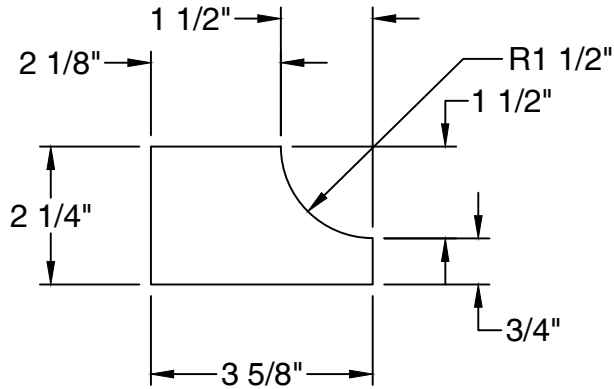

 INDICATES FINISHED FACES

DRAWING:
W2-S STD. MOD.
WATER TABLE UNIT

PROJECT:

PAGE: 1 of 1 DATE: 3 JAN 17

ARCHITECT:

CUSTOMER:

SALES REP:

SALES OFFICE:

PLANT:

BRICK NAME:

BRICK TYPE:

TEXTURE:

NUMBER OF FINISHED FACES: 3

TEXTURE DIRECTION: PLANT OPTION

CORING: PLANT OPTION

SIZE: STD. MOD. BOND:

ASTM STANDARD: C216, FBS, SW

COMPUTER FILE: W2-S-STDMOD

DRAWN BY: KEVIN LINDSTROM

This document is the property of GLEN-GERY CORPORATION and may not be reproduced without written permission from the appropriate Glen-Gery Representative. The contents of this document are advisory only. Responsibility for accuracy and applicability lies entirely with the Project Designer and/or Owner.