

This drawing has been reviewed for dimensions, faces, and specifications and I agree to them.

Qty : _____

Signature

Title

Date



DRAWING:
1/2" THIN BRICK
UTILITY END CAP

PROJECT:

PAGE: DATE:

ARCHITECT:

CUSTOMER:

SALES REP:

SALES OFFICE:

PLANT:

BRICK NAME:

BRICK TYPE:

TEXTURE:

NUMBER OF FINISHED FACES: 2

TEXTURE DIRECTION: PLANT OPTION

CORING:

SIZE: UTILITY BOND:

ASTM STANDARD: C216, TBS, SW

COMPUTER FILE:

DRAWN BY: KEVIN LINDSTROM

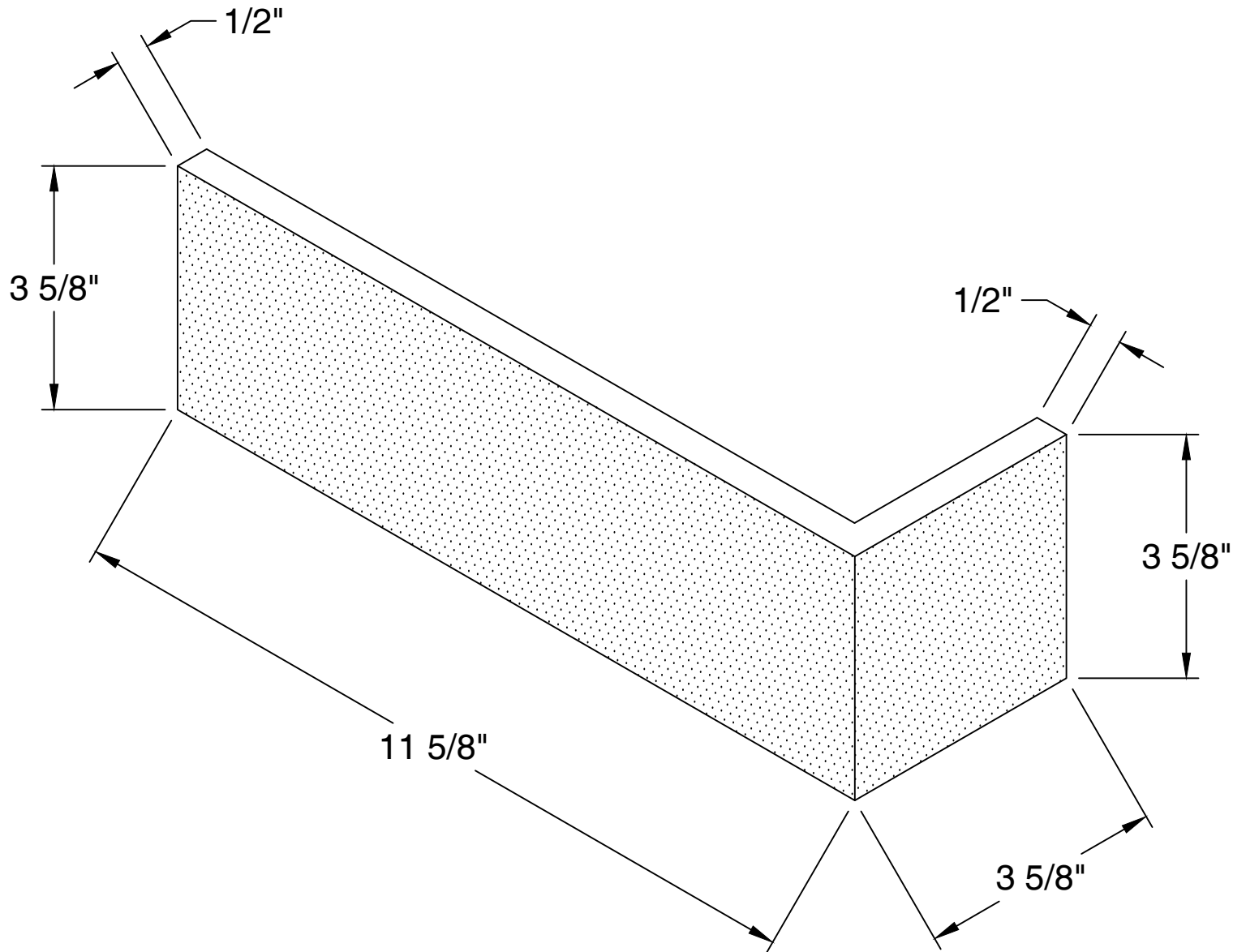

 INDICATES FINISHED FACES

This document is the property of GLEN-GERY CORPORATION and may not be reproduced without written permission from the appropriate Glen-Gery Representative. The contents of this document are advisory only. Responsibility for accuracy and applicability lies entirely with the Project Designer and/or Owner.