

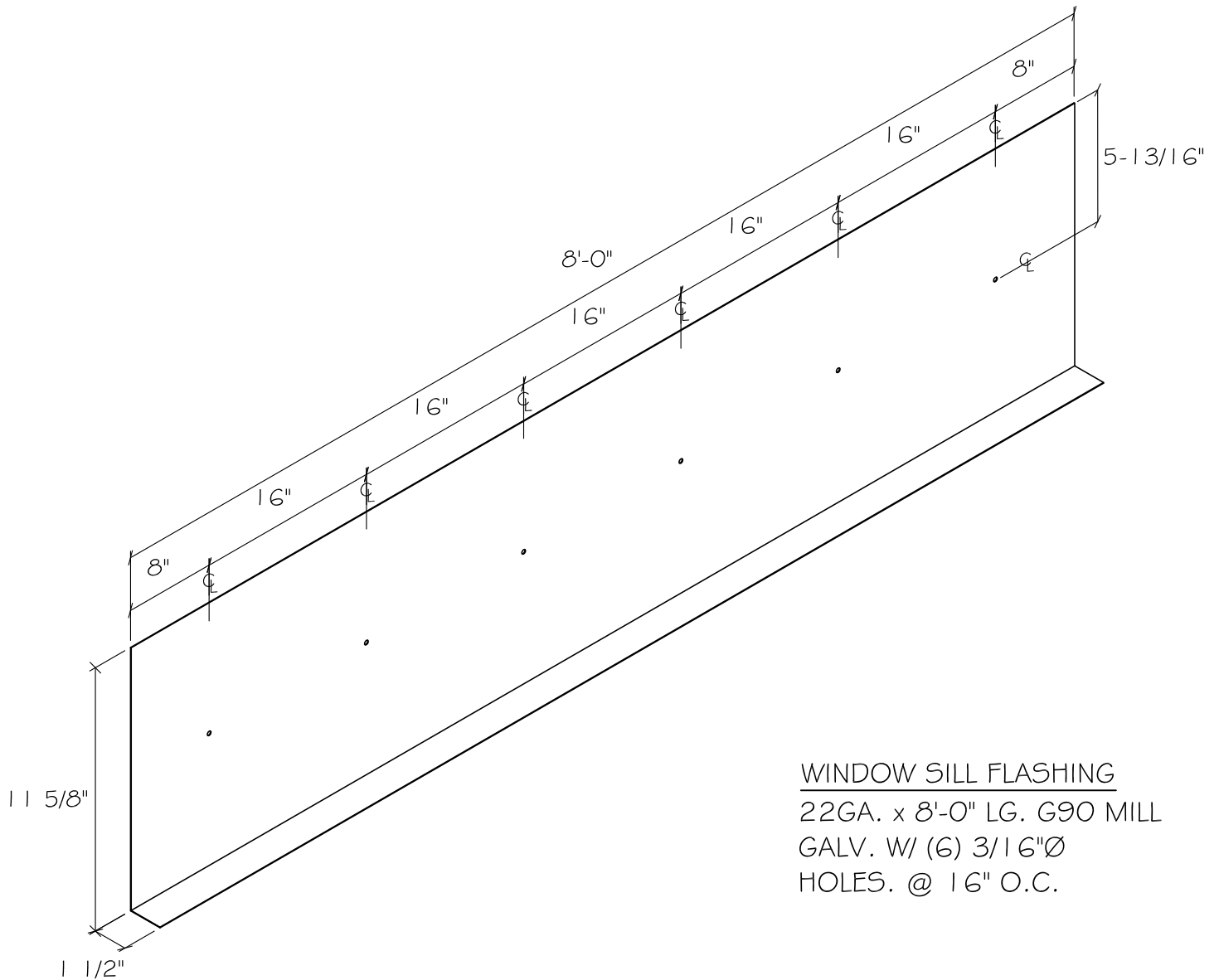

Glen-Gery

THIN TECH®



WINDOW SILL FLASHING
22GA. x 8'-0" LG. G90 MILL
GALV. W/ (6) 3/16"Ø
HOLES. @ 16" O.C.

PIECE QUANTITY:

PROJECT:

LOCATION: NEW YORK, NEW YORK

C/O: GLEN - GERY

DESCRIPTION: "STANDARD COMPONENT PART SHEET"

NO:

WF-4

ISSUE DATE: 01/03/12

SCALE: N.T.S.